

Installation Guidelines

KwikLok

Tools & Materials

- Dead Blow Hammer
- Chalk
- Cutting Board
- Tape Measure
- Safe Utility Knife
- Straight Edge

Materials

- KwikLok Tiles (6mm)
- KwikLok Edging (6mm)

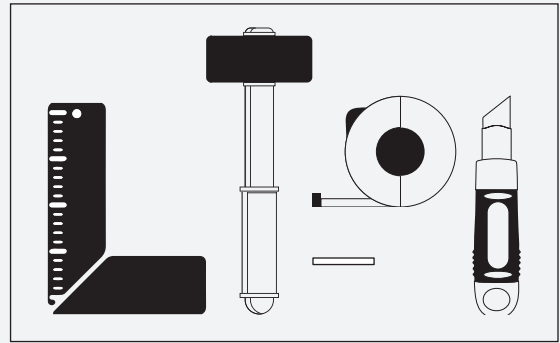

KwikLok

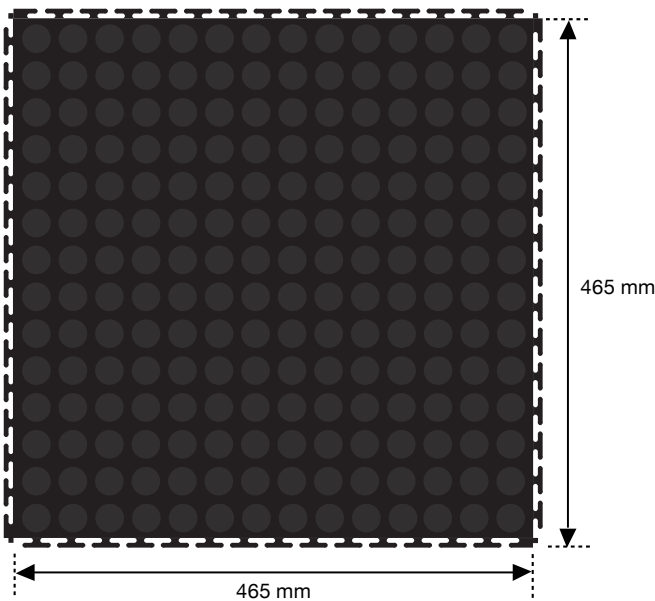

KwikLok Edge



KwikLok Corner Edge

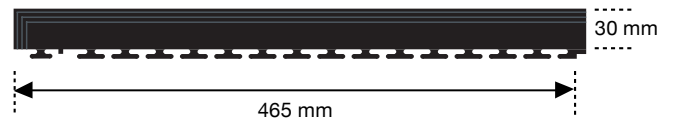

Preparation

KwikLok tiles can be laid on damaged or cracked subfloor surfaces. For best results it is advised to install on a level and clean floor. Simply follow these simple steps to achieve a durable, clean and adaptable flooring finish in your chosen area:



Clean

Sweep the existing floor to ensure that the surface is clean and free of dust and dirt.



Temperature

We advise that KwikLok tiles are laid in areas that have an ambient temperature between 16°C-24°C **(Let the tiles acclimatise for at least 24-48 hours before laying).**



Surface check

We recommend using a self-leveling repair compound in areas where there's variations in subfloor surface. If not addressed, floor tiles may 'dislocate' at the connection interlocks (The smoother the subfloor is the more even and resilient your KwikLok tile floor will be).



Humidity

Relative humidity in the room should not be more than 60% (ideal 30% to 60%).

Fitting Instructions

Tile Layout Guide

1. Measure the length & width of the room and divide the dimensions in two - then locate & mark the centre of the room where the centre of your first tile* will be. (This will be the starting point for the installation)
2. You can at this point check the number of tiles required to reach the walls in each direction. Remember you can cut the tiles to fit around the edges of the room.
3. Draw a chalk-line - - - through the start point parallel to the longest dimension. This is to act as a guide for keeping tiles parallel to the walls. To ensure the line is parallel to the walls, measure out from the wall near each end of the room, mark the points on the floor and draw the chalk-line between the points.

It's very important to leave approximately 5mm expansion gap between the tiles and any walls/fixed points for expansion. Sometimes for larger areas a bigger gap may be required.

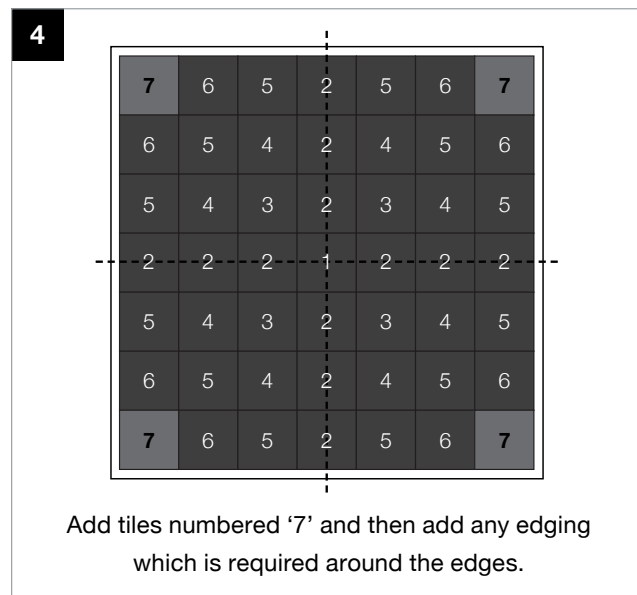
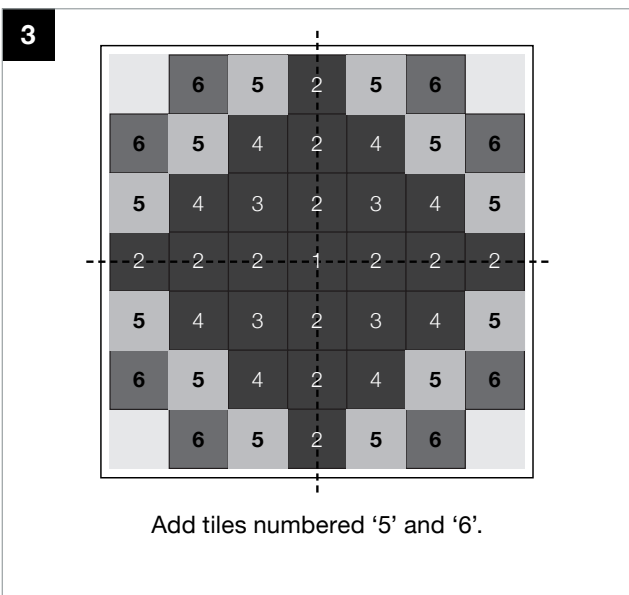
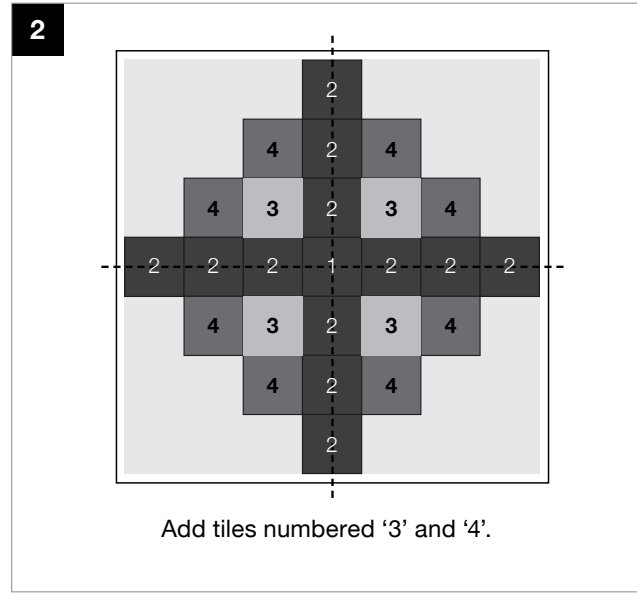
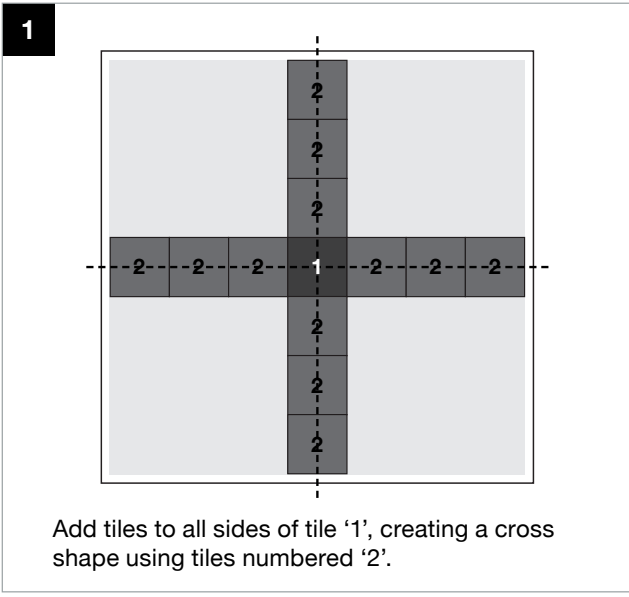
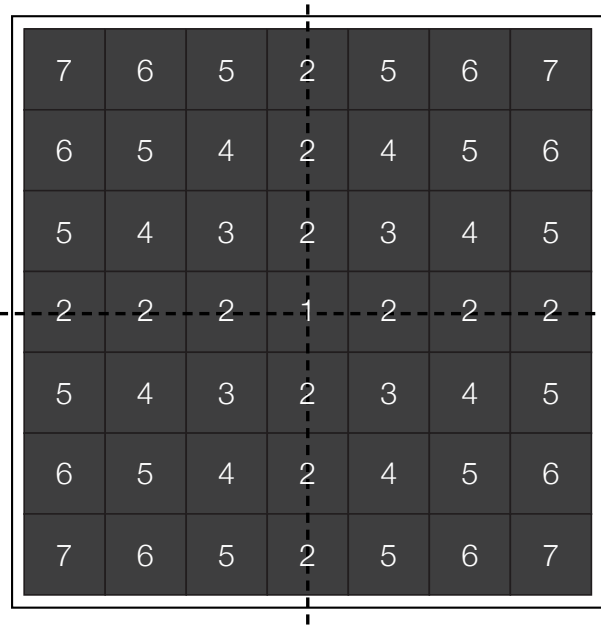

Finishing off

The 5mm gap between the tiles and fixed points can be sealed with an acrylic putty or silicone sealant from a glue gun. Please wipe off excess sealant immediately with a damp cloth.

Doorways

In doorways, an edging tile can be used if tiles are to meet a different floor covering. If the tiles are to continue through a doorway, no edging is required but the tiles in the doorway should be adhered with glue.

Post completion of work

For best results leave the installation area in good condition by removing all debris by cleaning and vacuuming any residual dust. The completion of the work should be done straight after completion of installation.

Cleaning and maintenance

KiwkLok floors can be cleaned and maintained easily using a damp mop, preferably using a pH balanced floor cleaning product. (KiwkLok floors can easily withstand cleaning using an industrial rotary mop). For best results give the floor a light clean on frequent occasions.

Sunlight

Not suitable for regular direct sunlight, especially during the summer months. If used in garages we suggest that the garage door is kept closed to minimise sunlight exposure.

MORE THAN JUST
MATTING